



×

H U S K

A Meeting of Minds

Kitchen Collection
2024 Brochure



Table Of Contents

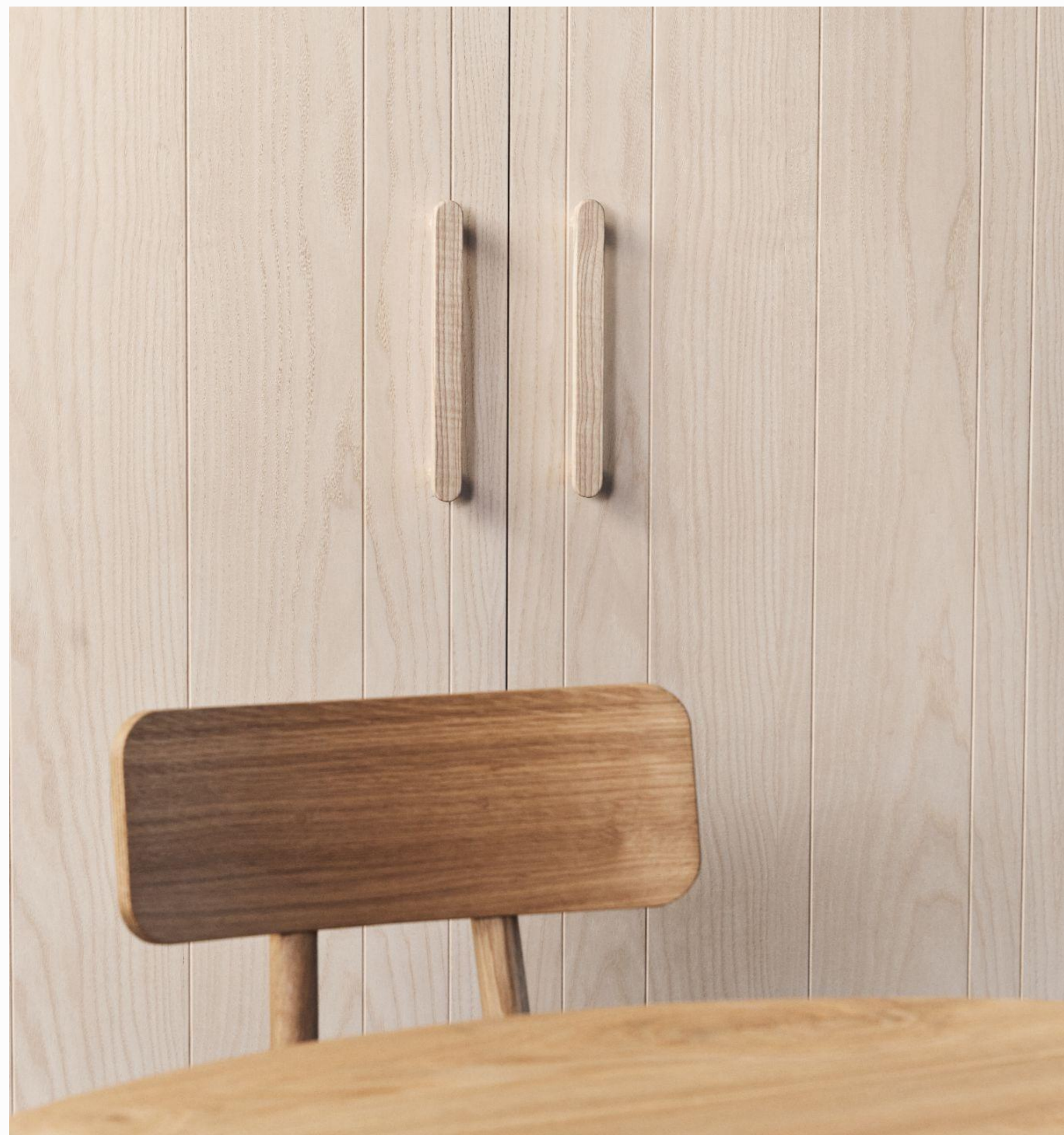

- 1. Contact
- 2. A Meeting of Minds
- 6. Fronts
- 10. Worktops
- 11. Example Layouts
- 14. Hardware
- 15. How It Works
- 16. Get in Touch
- 17. Lookbook
- 21. Terms & Conditions

Contact

HUSK

📍 Made By HUSK, Ltd.
Unit D, St Vincent Trading Estate
Bristol, BS2 0UY

📧 shop@madebyhusk.com

☎ [0117 462 1661](tel:01174621661)

ANOTHER COUNTRY

📍 Another Country
18 Crawford Street, Marylebone
London, W1H 1BT

📧 shop@anothercountry.com

☎ [020 7486 3251](tel:02074863251)



A Meeting Of Minds



The HUSK x Another Country collection is the first range of bespoke kitchen fronts designed by Another Country to work for IKEA & Howdens cabinets. With a shared ethos and passion for high-quality craftsmanship, sustainability and considered design, the collaboration brings a timeless collection in a range of natural timber and colours that evoke the West Country landscape.

Inspired by the West Country

This new range is available in a natural Ash veneer or painted in a variety of five earthy tones inspired by the scenic West Country landscape shared by both brands - including Mist Green, Devon Red, Cornfield Yellow, Purbeck Grey and Ashmore Dark Green.

The natural Ash veneer offers a pared-back Scandi look and feel. The design is a celebration of the timber itself, which looks great in both modern and period spaces.

The V Groove spacing is inspired by ancient ridge & furrow plough lines, and adds a playful touch to the design as you travel from door to door - with the option to combine different pattern formations affording bountiful possibilities.



Sheepstor, Devon

Designed by Another Country in London

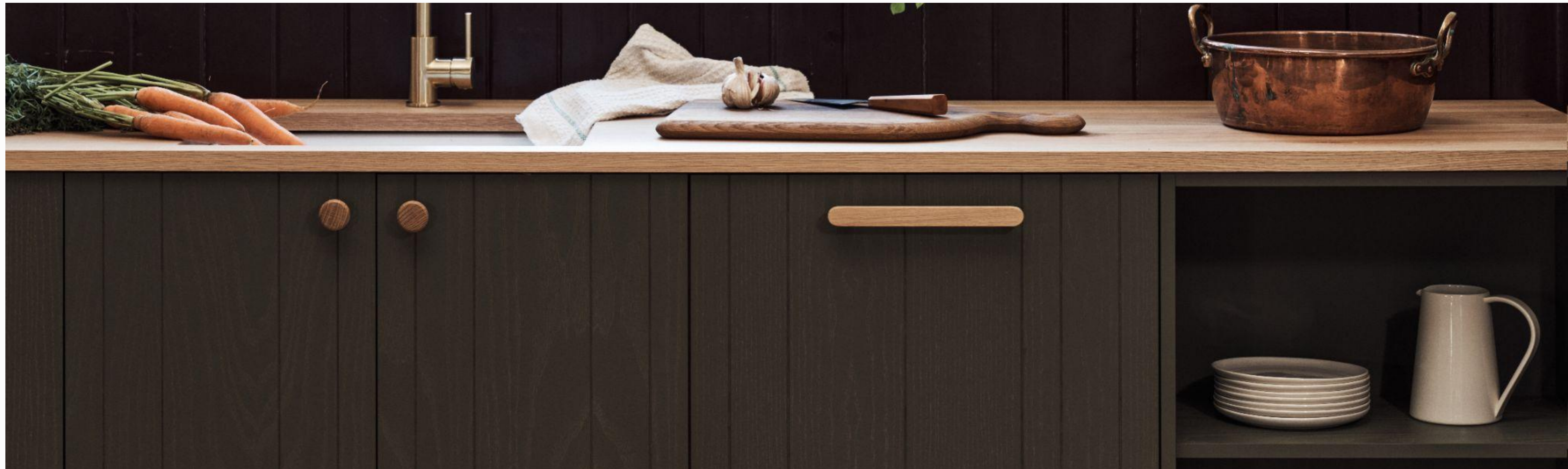

Designed in-house by Another Country, this new kitchen range offers a contemporary take on HUSK's classic V Groove design, and is available in a broad range of earthy tones. This partnership sees two brands that share an ethos and passion for high-quality craftsmanship, sustainability and considered design come together to create a timeless collection.

Made By HUSK in Bristol



Every kitchen front is made in HUSK's solar-powered workshop on the banks of the River Avon. HUSK's dedication to sustainability is exemplified by the use of responsibly-sourced timber & water-based paint, creating sturdy & stylish kitchen fronts that will stand up to daily use while retaining their natural elegance. A choice of three expressive V-Groove patterns and six unique surface finishes provides design options to suit every kitchen space.

Fronts

All fronts in the HUSK x Another Country collection can be made to fit new IKEA or Howdens kitchens, and can also be produced on a bespoke basis. That's one of the many benefits of making everything in-house. Book a 1:1 Design Consultation with a member of the HUSK's expert team to be guided through the process.

All Door Fronts are available with and without grooves. Drawer fronts are provided without grooves as standard.

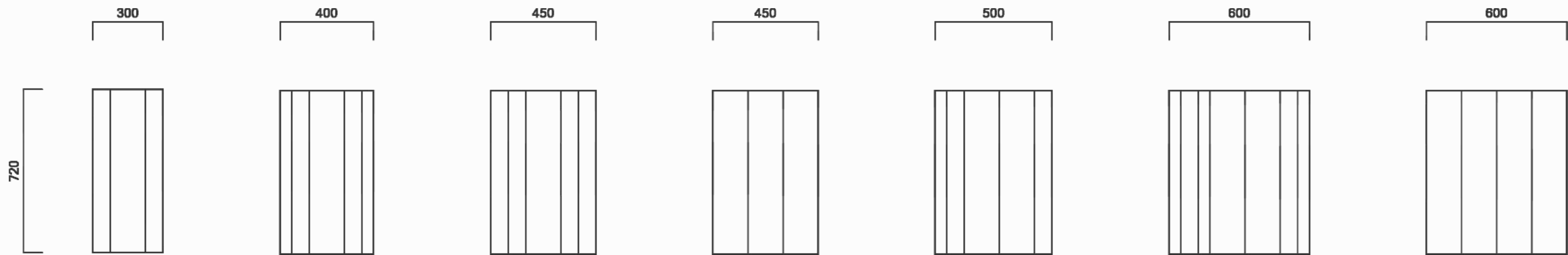

The HUSK x Another Country range is available to fit all IKEA & Howdens cabinet dimensions. Example Groove Layouts represent just a small selection of possible sizes & groove combinations. To discuss further design combinations, please get in touch with HUSK.

V-Grooves: Inspired by Nature



Biophilic design is deeply rooted in this collaboration. Inspired by the South West's far-reaching fields, our V-Groove designs follow ancient ridge & furrow patterns left in the soil by our ancestors. Created by a system of ploughing used extensively in the Middle Ages, examples of Ridge lines & Furrow troughs exist across Europe, but only where the soil has been left untouched since the Middle Ages. Our non-grooved doors and drawer fronts draw inspiration from Fallow fields: those which have been left unploughed to restore their organic balance and replenish moisture content.

V-Groove Patterns

Our V-Groove door finishes have been carefully designed to offer a unique, customisable blend of linear patterns in your kitchen.



Ridge

The orderly lines of the Ridge Front create a steady vertical flow - perfect for taller units & double doors.

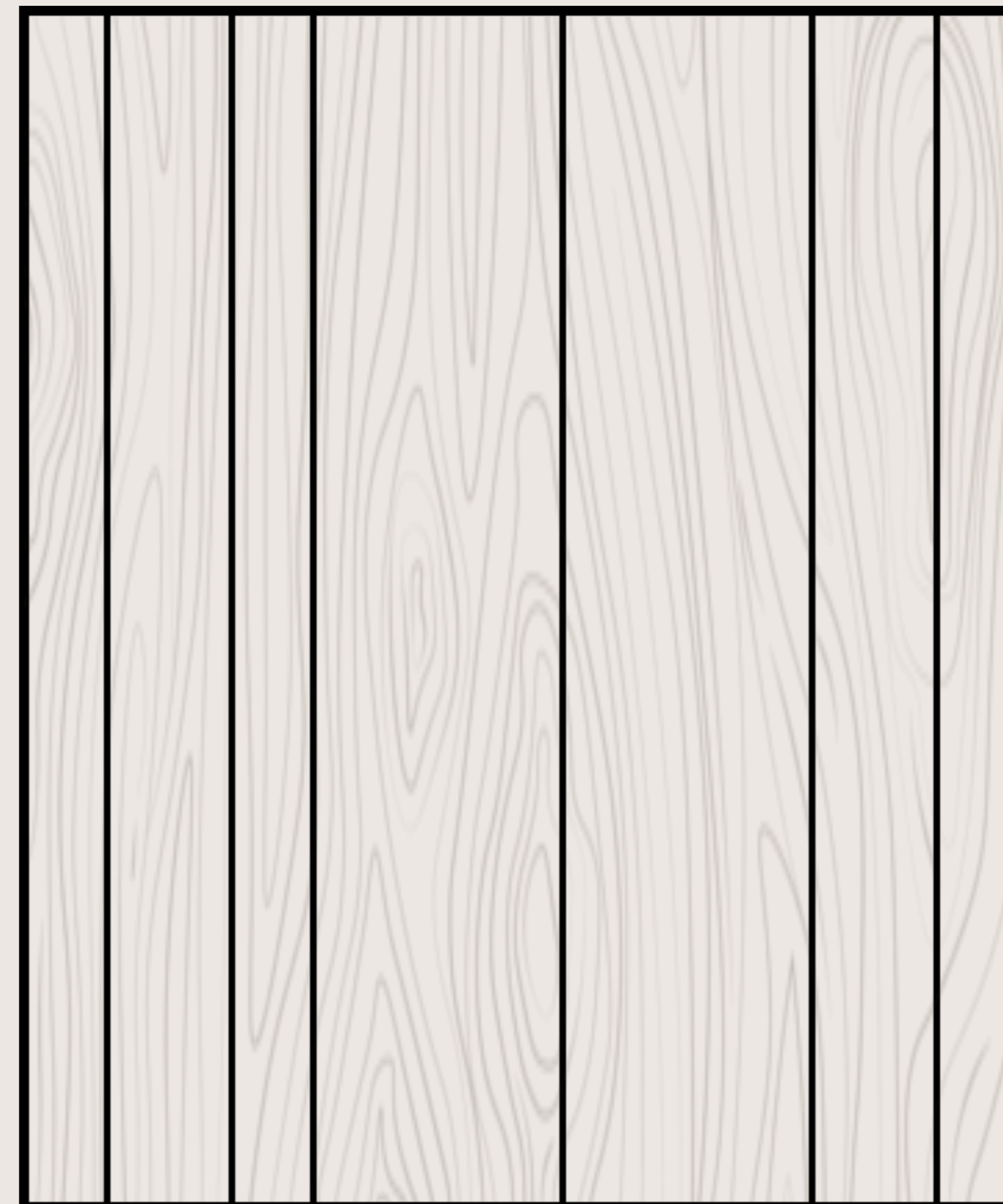

Furrow

Introduce irregularity with the Furrow Front, ideal for single cabinets.



Fallow

Drawers are provided with the Fallow Front as standard, allowing the grain to take centre stage.

Finishes & Colours

Painted



Devon Red

Painted Finish

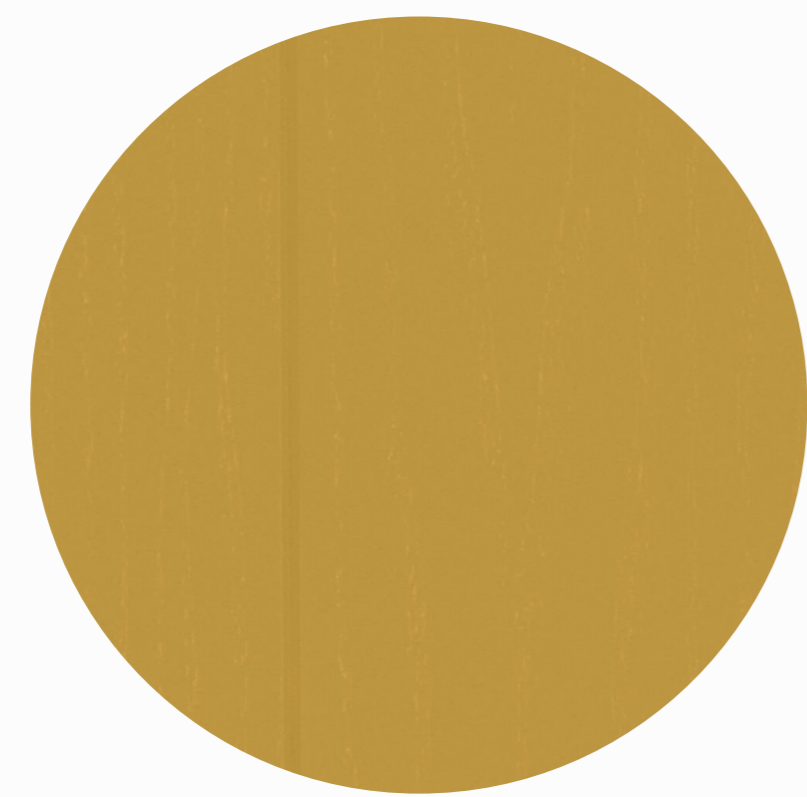

Cornfield Yellow

Painted Finish

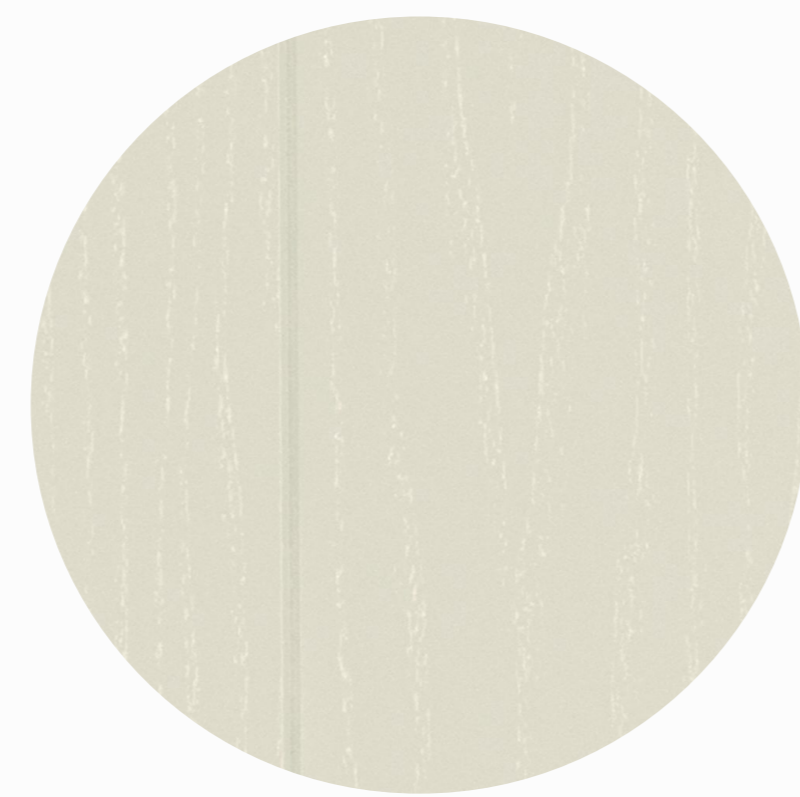

Purbeck Grey

Painted Finish

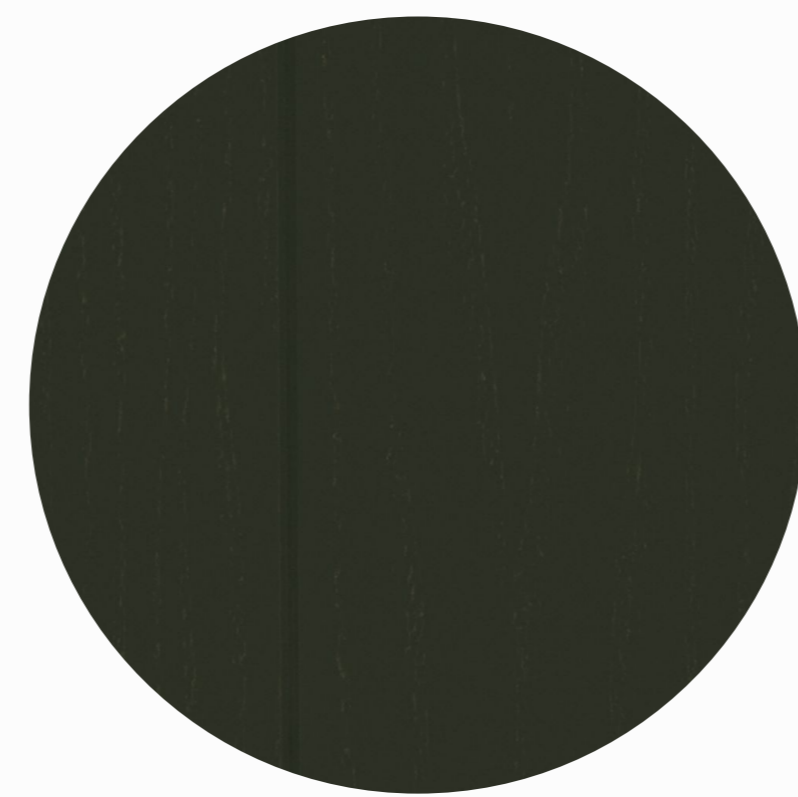

Ashmore Green

Painted Finish

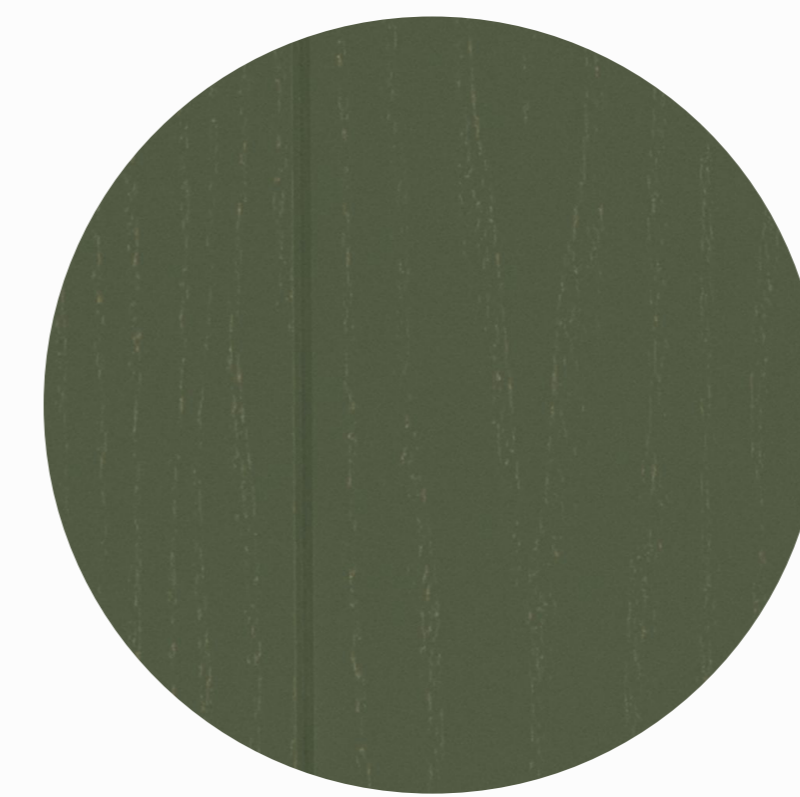

Mist Green

Painted Finish

19mm Thickness

Veneered



Ash

Veneered Finish

22mm Thickness

Fronts are available in a natural Ash veneer or painted in a variety of five earthy tones inspired by the scenic West Country landscape.

Like what you see? [Order a sample](#)

Worktops

Stone



Just White

£££

12mm Thickness

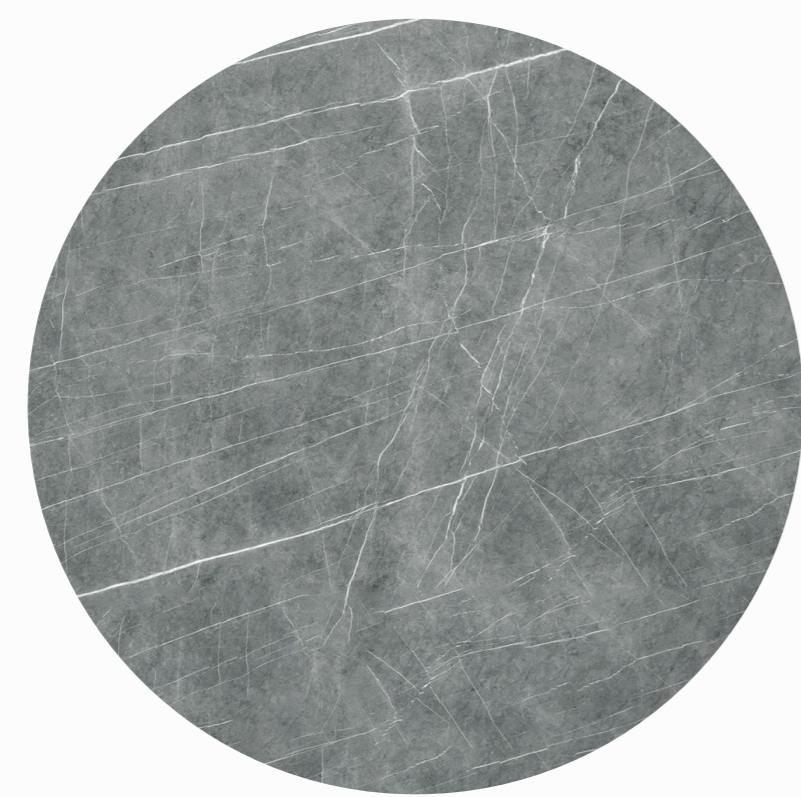

Zaha Stone

£££

12mm Thickness



Mont Blanc Silk

£££

12mm Thickness

HUSK provides a range of over 45 durable stone worktops, which have been carefully selected to suit all budgets.

Wooden



Prime Oak

££

Full Stave
Variable Thickness



Ash

££

Full Stave
Variable Thickness



Iroko

££

Full Stave
Variable Thickness

[Explore more worktop options](#)

Example V-Groove Layout 1

Front View

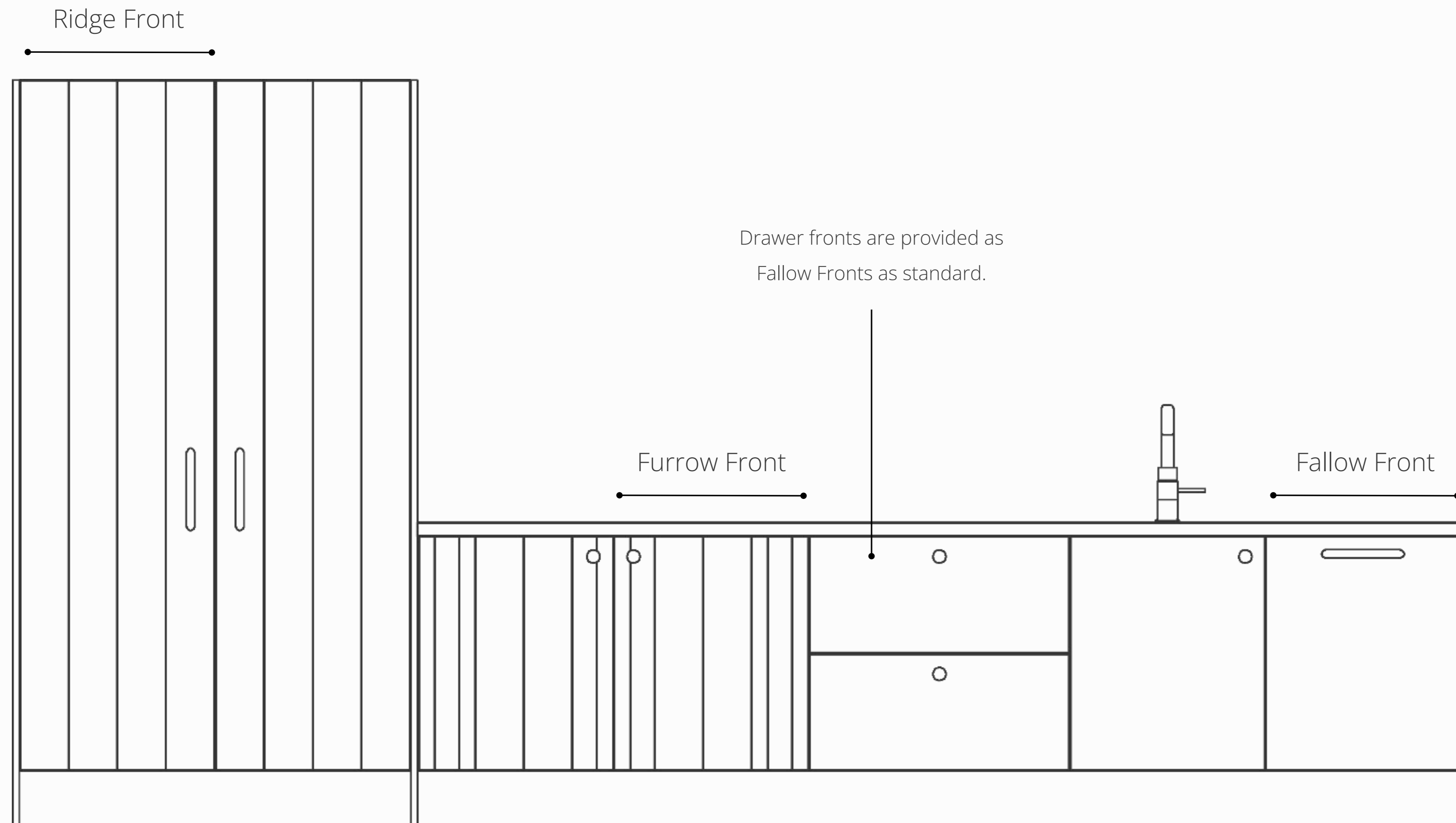

Side View

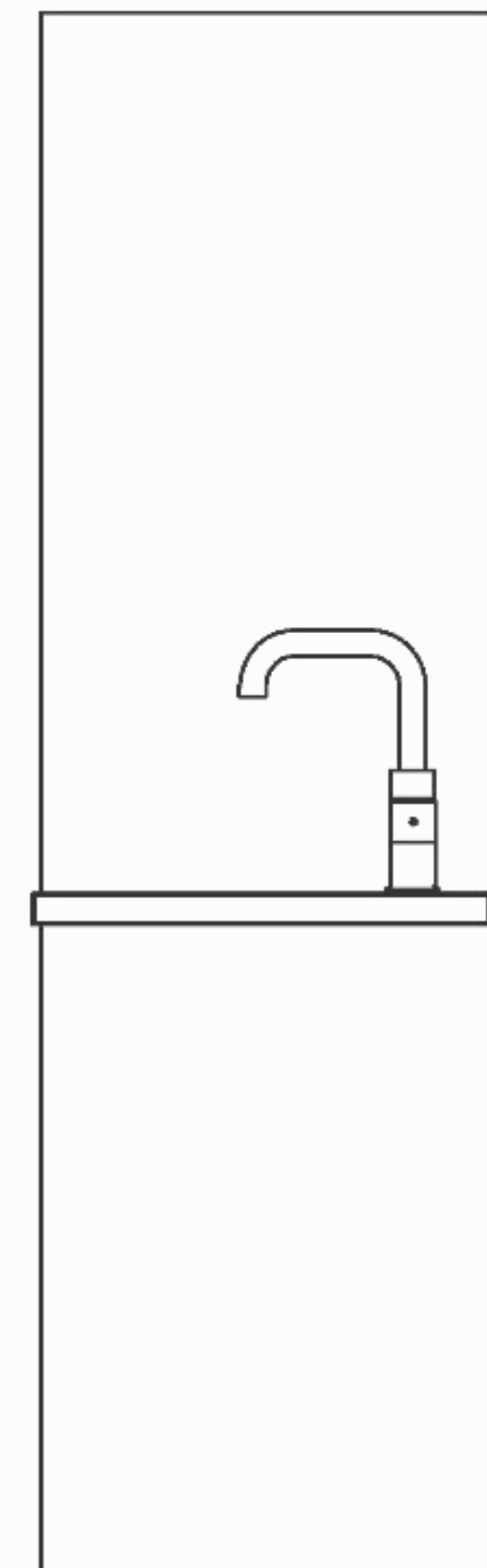

Example V-Groove Layout 2

Front View

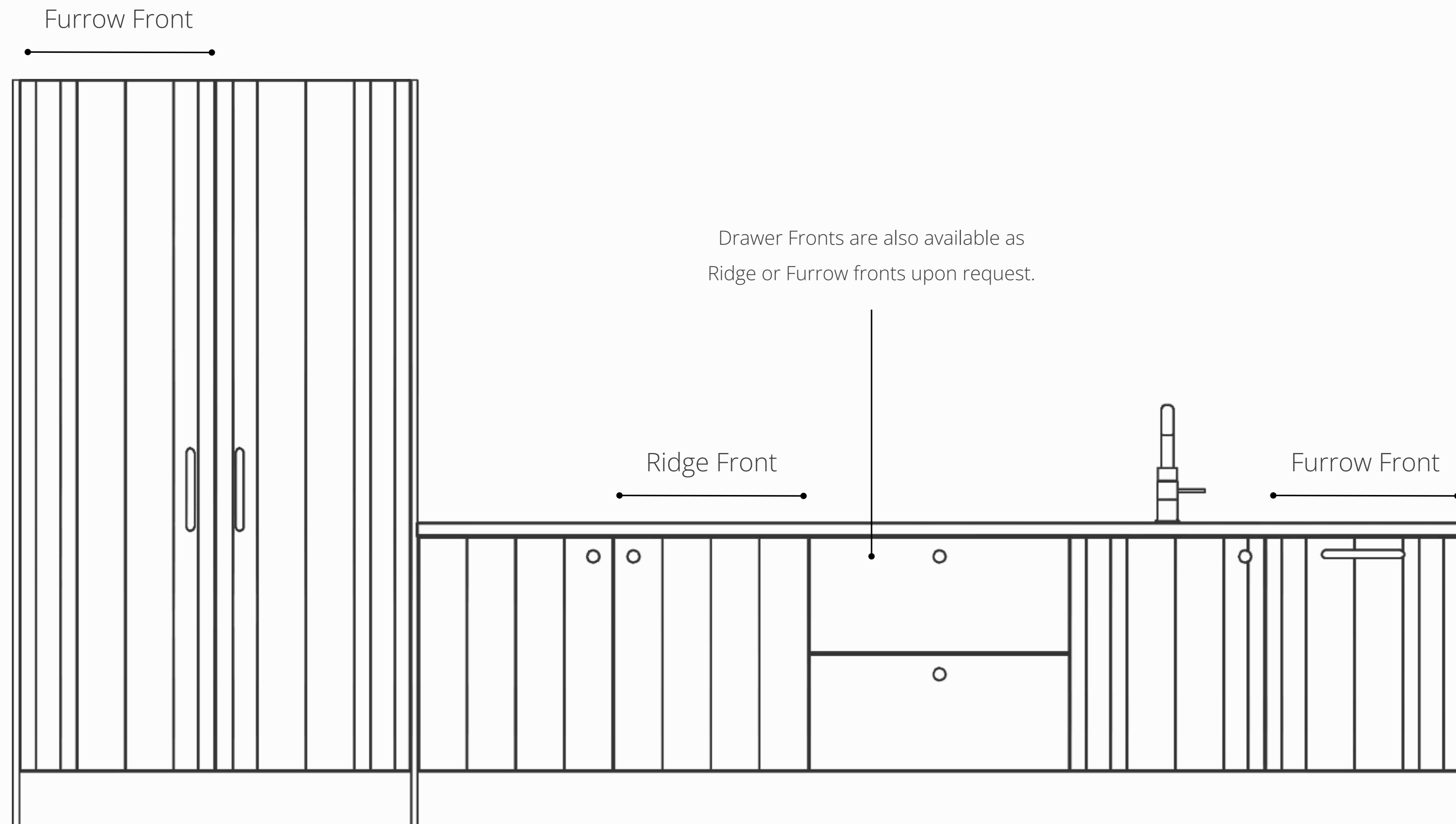

Side View

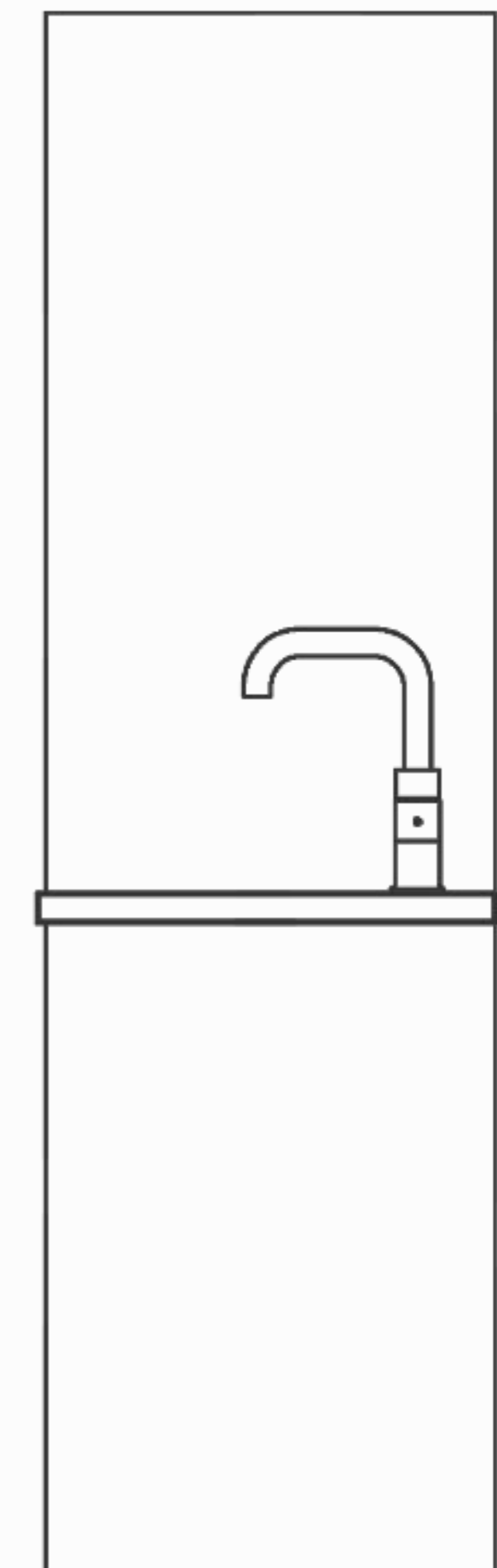

Example V-Groove Layout 3

Front View

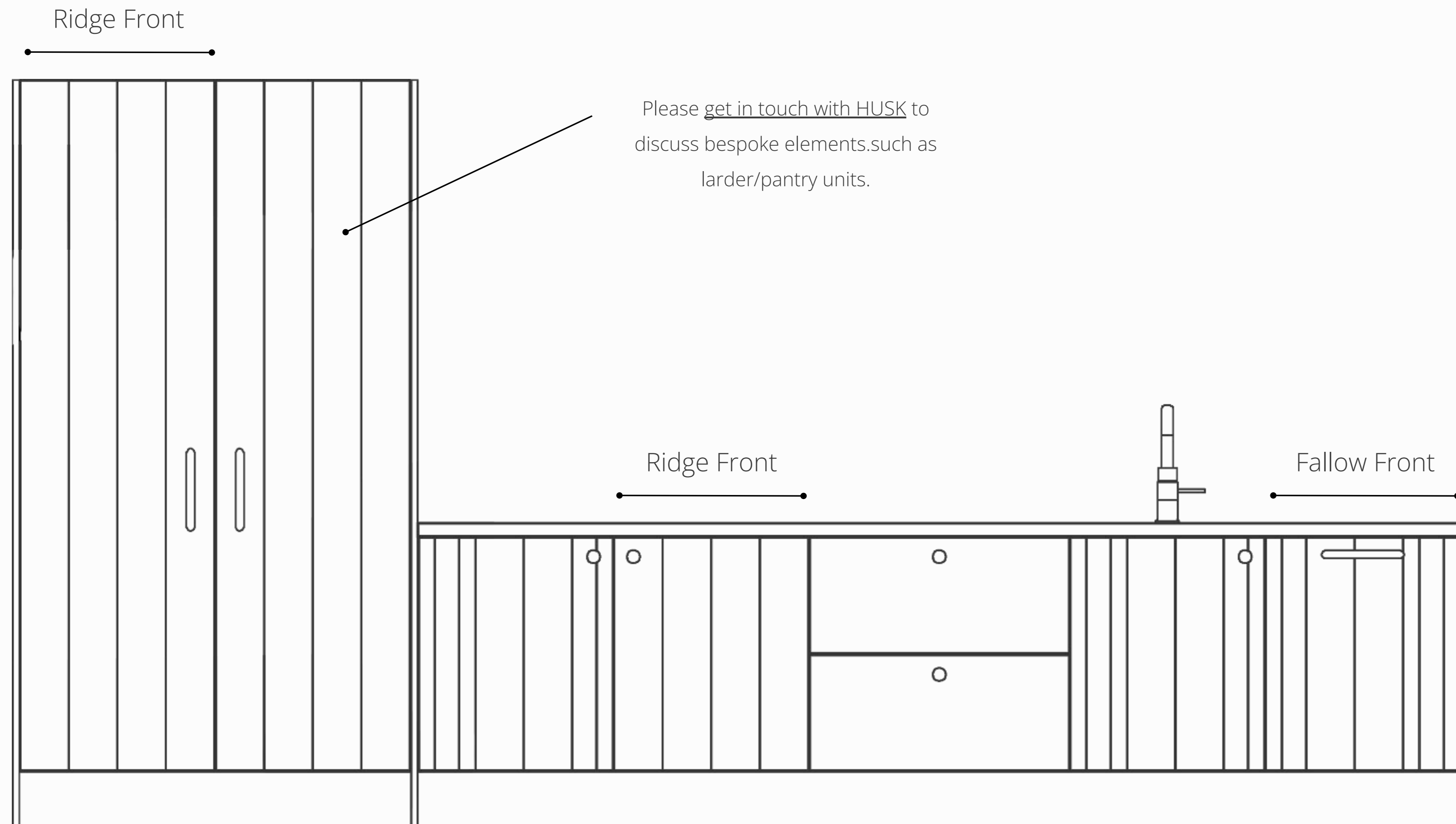

Side View

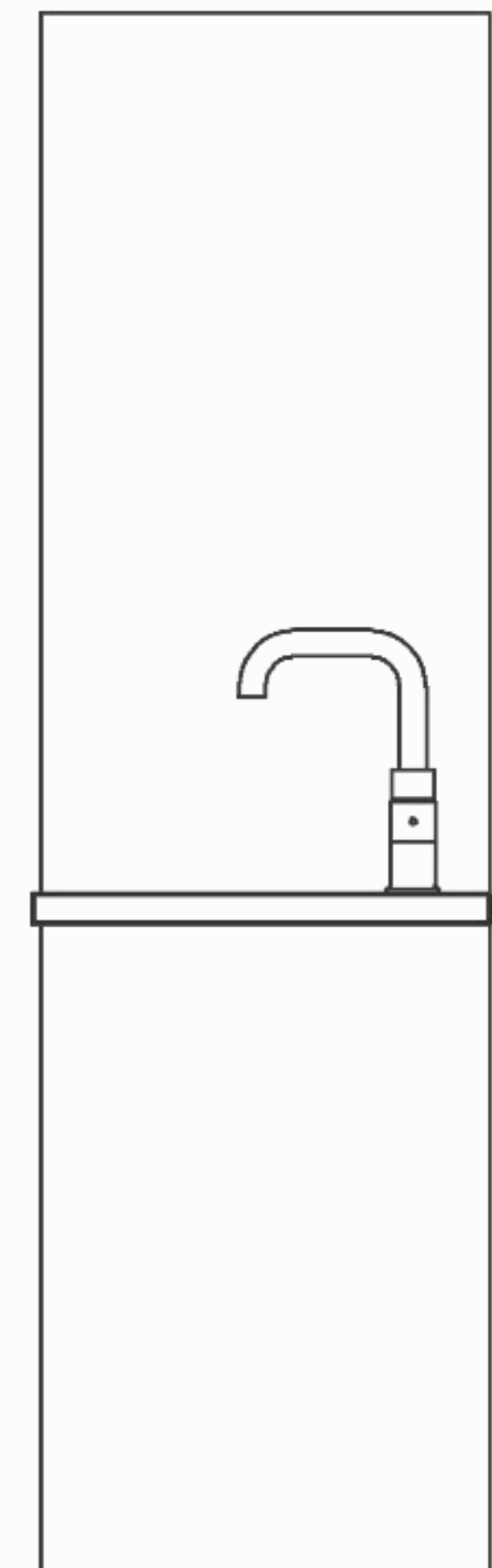

Hardware



Knob

Solid Hardwood Knob (Oak)

Width 40mm

Available in Oak and Ash.



Pull Bar

Solid Hardwood Pull Bar (Ash)

Width 250mm

Available in Oak and Ash.

How it works

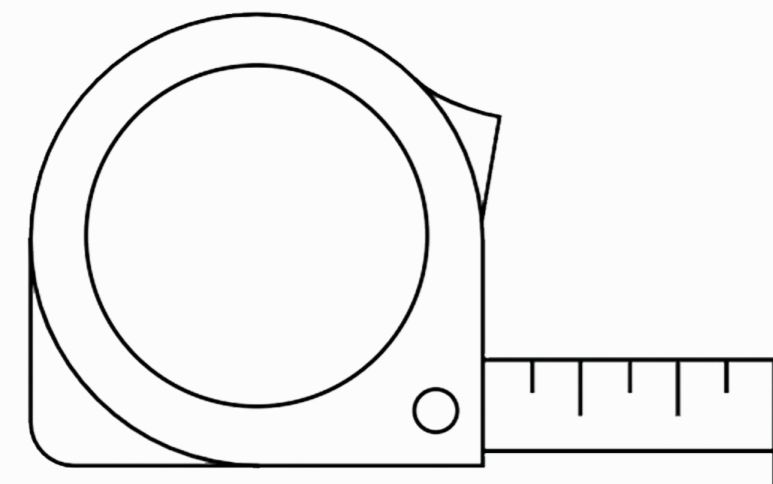

Step One Measure & Design

Measure your space, then talk to IKEA or Howdens about your requirements and their processes.

IKEA and Howdens have great kitchen planning teams to help guide you towards the best layout for your space.

Remember to design your IKEA or Howdens kitchen with HUSK fronts (and worktops*) in mind.

Place your order with IKEA or Howdens, to include everything except the doors (and worktops*).

HUSK offers a free [Sense Checking service](#) if you'd like someone to look over your IKEA or Howdens order before you place it.

Step Two Order Cabinet Frames

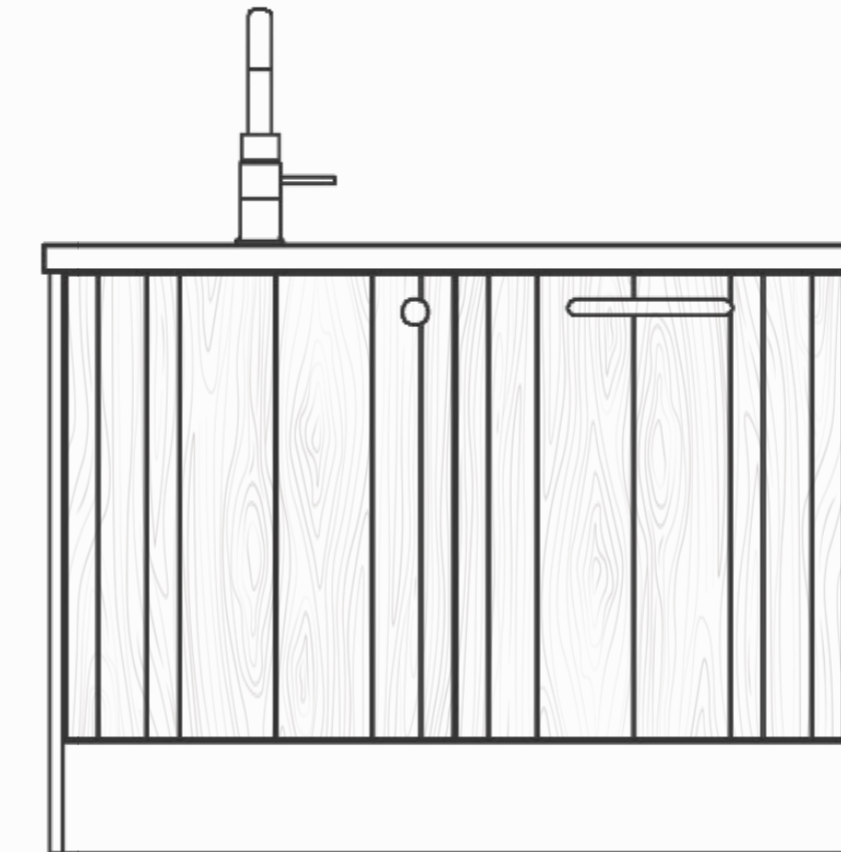
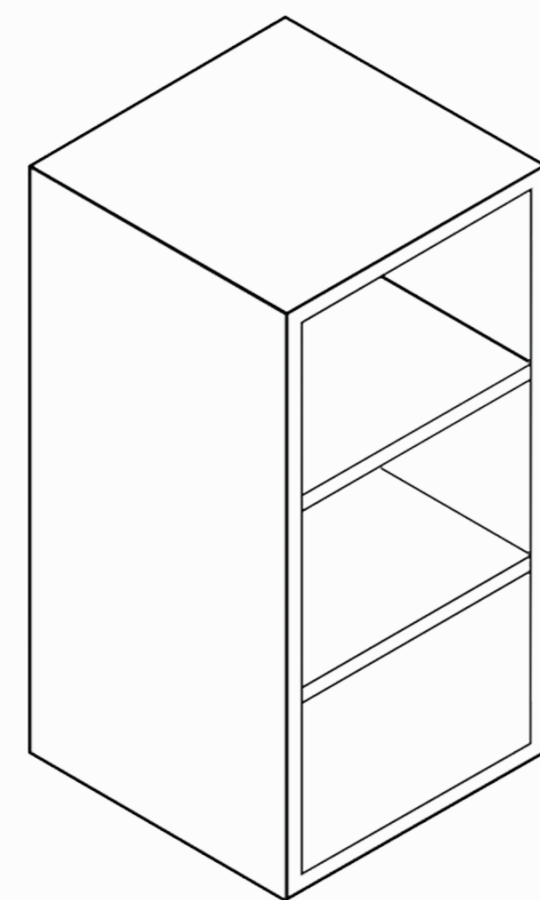

Step Three Order HUSK x AC Fronts

Browse HUSK's website and order samples before [booking a 1:1 virtual consultation](#) with one of their design team.

You can also visit a HUSK or Another Country Showroom in Bristol, Dorset or London to view the collaboration in the flesh and pick up samples.

Once you're happy with your choices, place your order with HUSK - and their Bristol workshop team will start making your kitchen to order.

Your order is delivered straight to your door from Bristol by a dedicated courier - and then it's over to you to fit.

The collection is designed to fit your specified kitchen with ease.

An in-depth installation guide is provided as standard, and HUSK's design team are available over the phone to offer installation support.

Step Four Delivery & Fitting

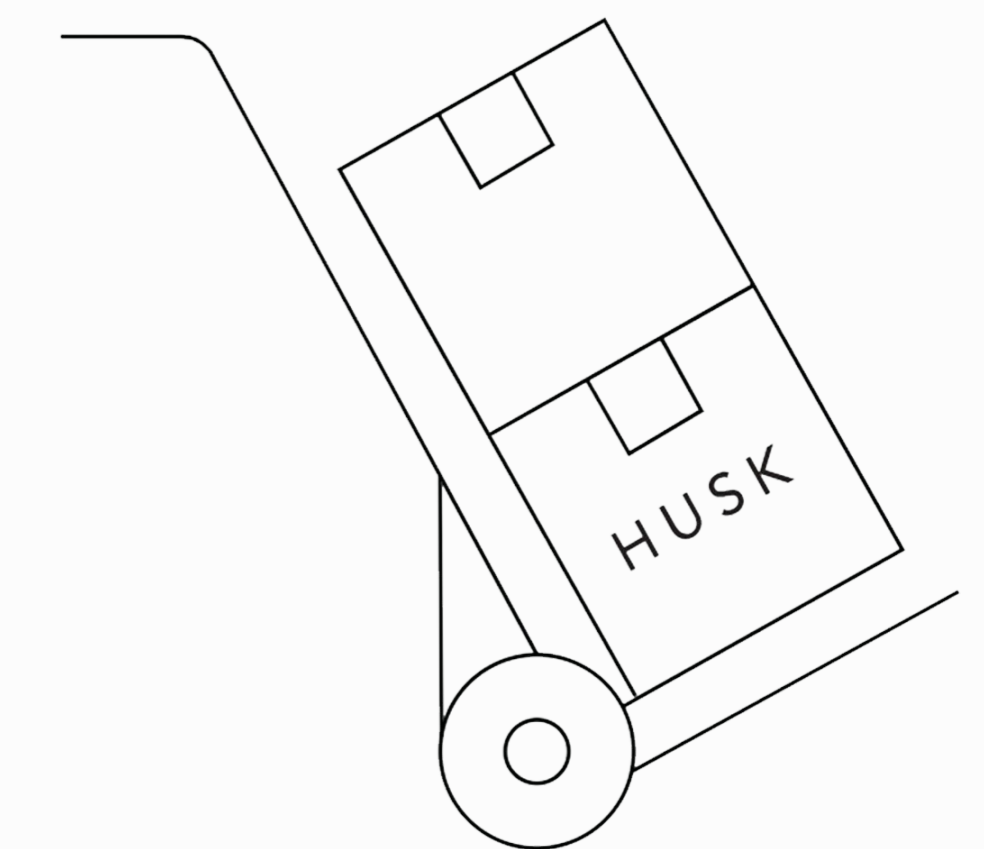

* The HUSK x Another Country fronts are paired with a selection of [Prime Oak, Ash & Iroko wooden worktops](#) as standard. Stone worktops are also available.

Get in touch

We understand that a new kitchen is a huge undertaking on any scale, so HUSK and Another Country are here to help.

You can visit our showrooms, call or email us and we'll be happy to guide you through your design process. You can also [Book a 1:1 Virtual Consultation](#) with a member of the HUSK Design Team for a more in-depth chat. For a free quote please email your IKEA or Howdens kitchen plan to shop@madebyhusk.com.

View a Display Kitchen

Display kitchens and samples are available to view at Another Country's Showrooms in Dorset & London.

You can also visit HUSK's Bristol Showroom to view samples and tour their Solar-Powered Workshop. If you're a little further afield, we recommend pairing a Bristol visit with an [IKEA](#) or [Howdens](#) Consultation.

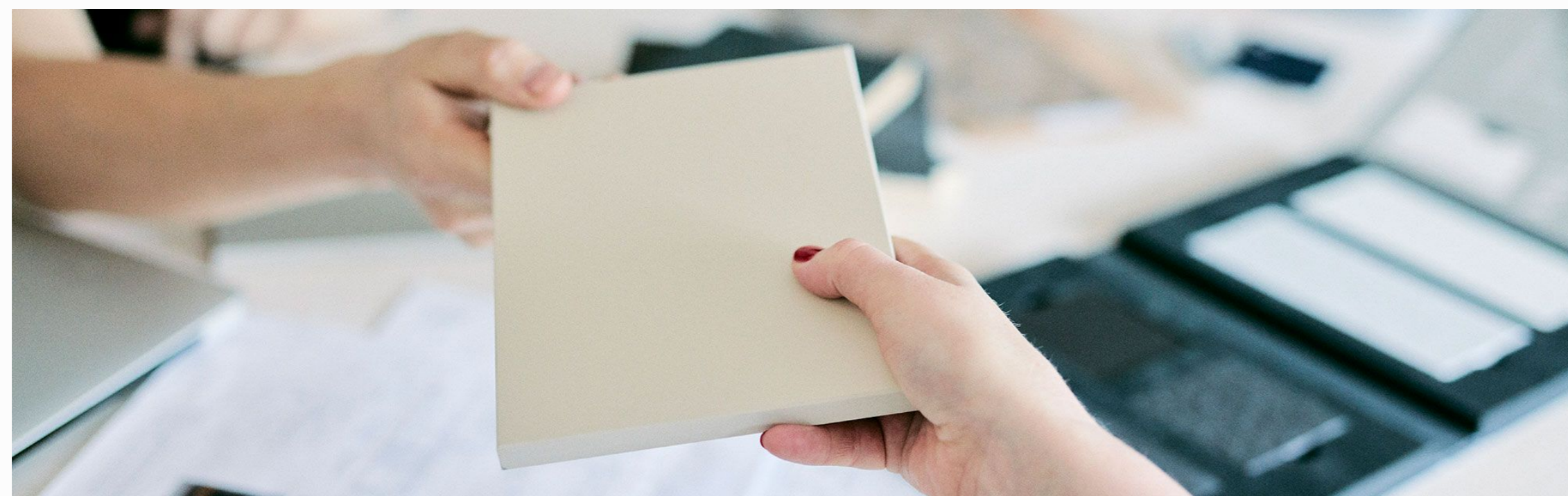

Visit a showroom

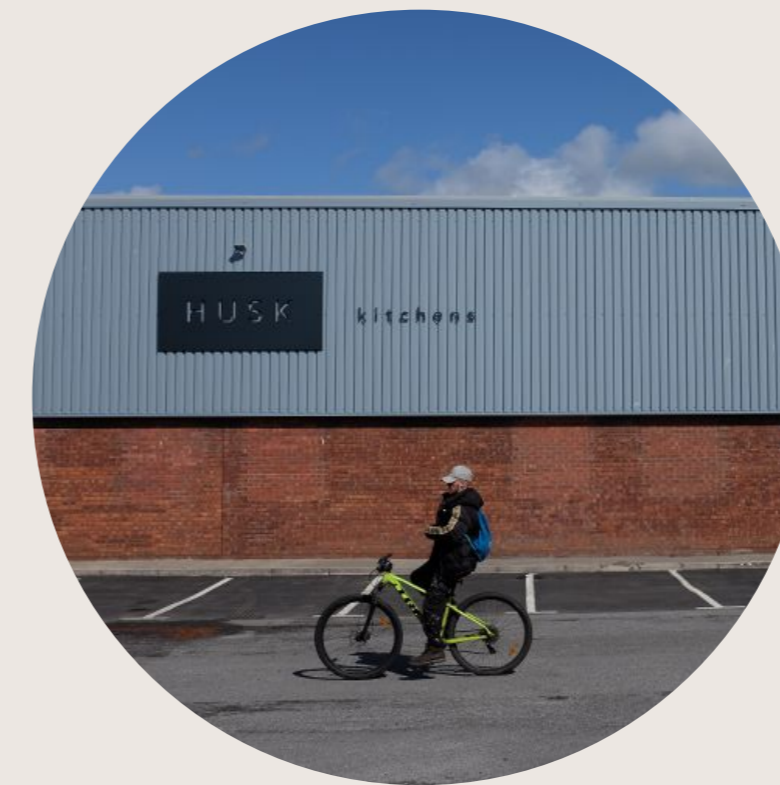

HUSK Bristol Showroom & Workshop
Unit D, St Vincent Trading Estate
Bristol, BS2 0UY



shop@madebyhusk.com



[0117 462 1661](tel:01174621661)



Another Country London Showroom
18 Crawford Street, Marylebone
London, W1H 1BT



shop@anothercountry.com



[020 7486 3251](tel:02074863251)



Another Country Dorset Showroom
Unit 5, Chaldicott Barns
Shaftesbury, Dorset, SP7 9AW



chaldicott@anothercountry.com



[01747 445 695](tel:01747445695)



Mist Green Fronts



Prime Oak Worktops,
White Tint Applied On Site



ac Hardy Dining Table & Chairs





Ash Veneer
Fronts



Mont Blanc Silk
Worktops

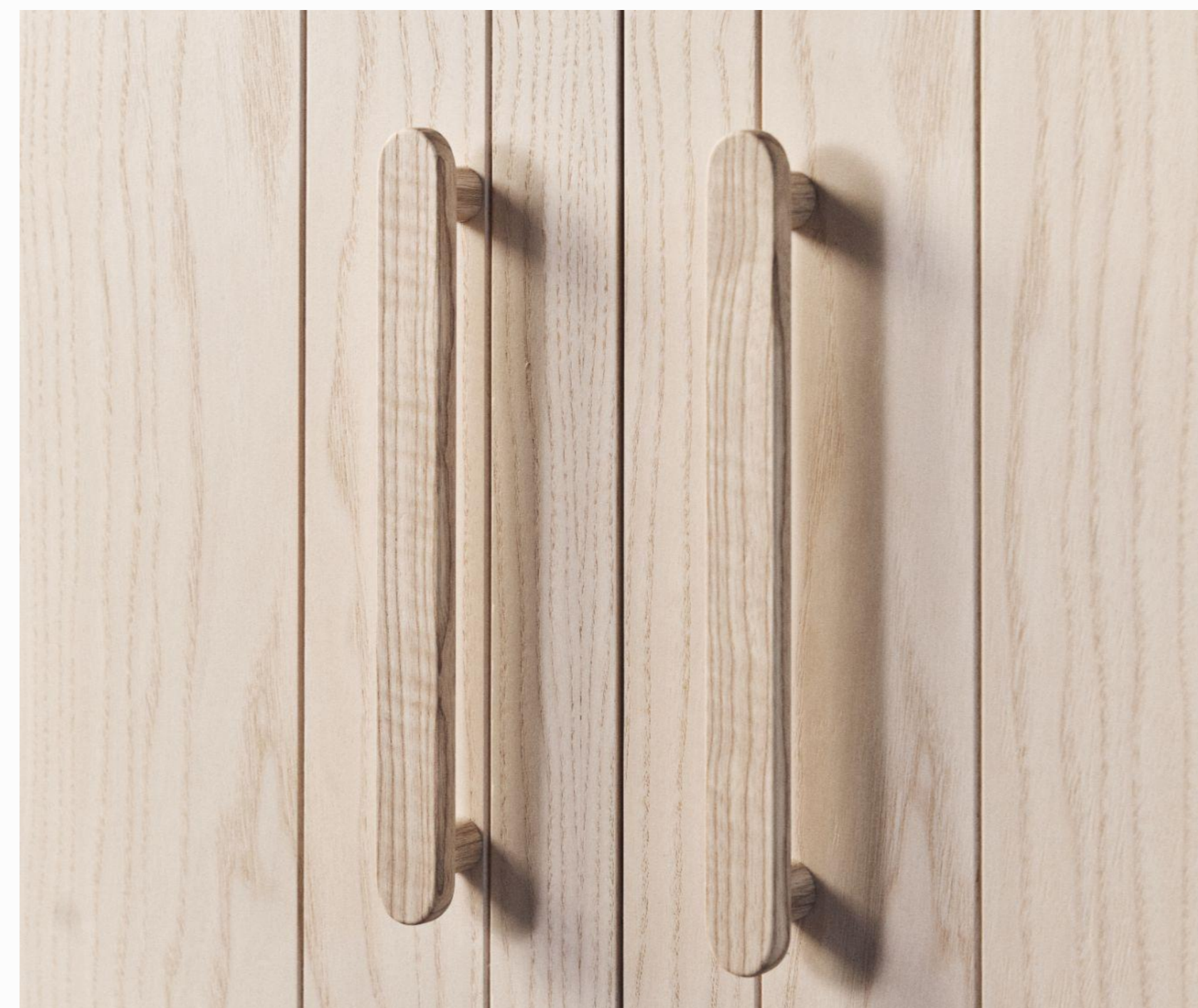



Ashmore Green
Fronts



Mont Blanc Silk
Worktops



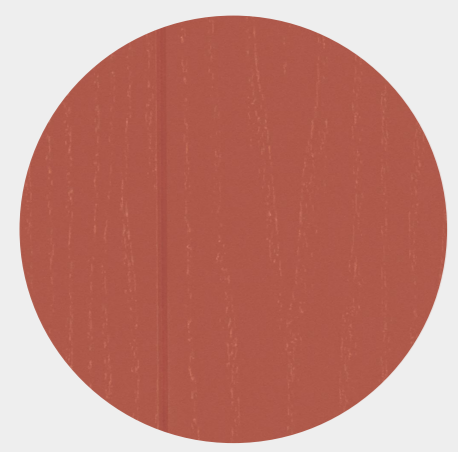

Devon Red
Fronts



Prime Oak Worktops,
Hand-oiled On Site



ac Hardy Dining Table & Side Chair

ac Dorset Showroom

Terms & Conditions

The HUSK x Another Country kitchen collection is subject to terms and conditions as laid out [on HUSK's website](#). By ordering from HUSK you agree to these terms and conditions.

HUSK's estimated **Lead Time** for the production of made to order items is 8-12 weeks*. On completion of production there may be up to 5 working days extra for delivery.

Deliveries are made by a dedicated courier from HUSK's Workshop to your address, and are kerbside only - delivery will be made as close to the delivery address as the courier can reasonably access.

Once the goods are removed from the delivery vehicle all liability passes to the customer. HUSK offers a **2 Year Warranty*** against *production defects* on all kitchen fronts as standard.

For a full list of terms and conditions please refer to [HUSK's website](#).

* Accurate as of January 2024

